

studio
industry
nature
architecture
reproduction

sinar[®]
sinar

Instruction Manual

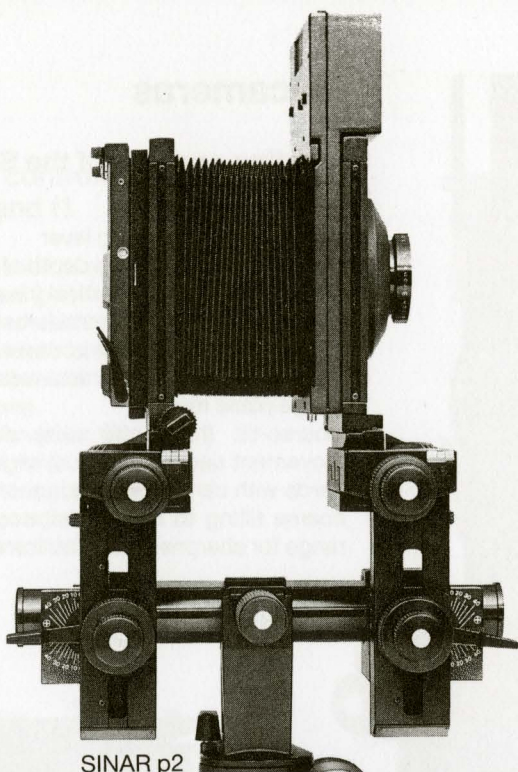

SINAR p2

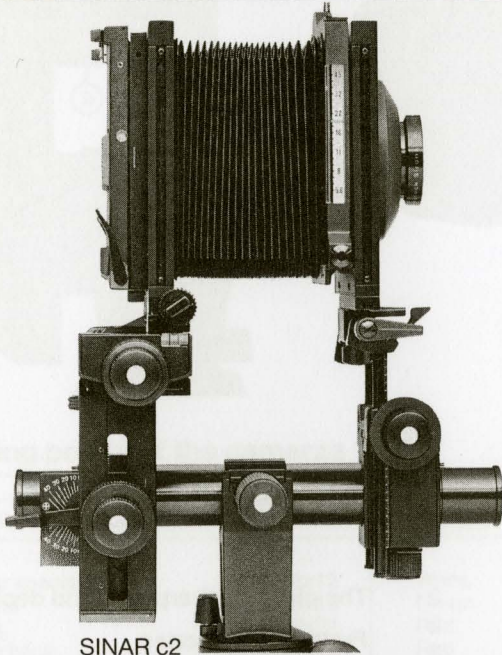

SINAR c2

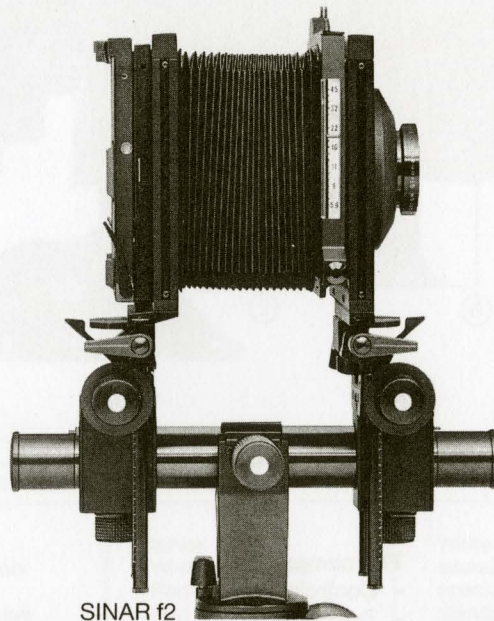

SINAR f2

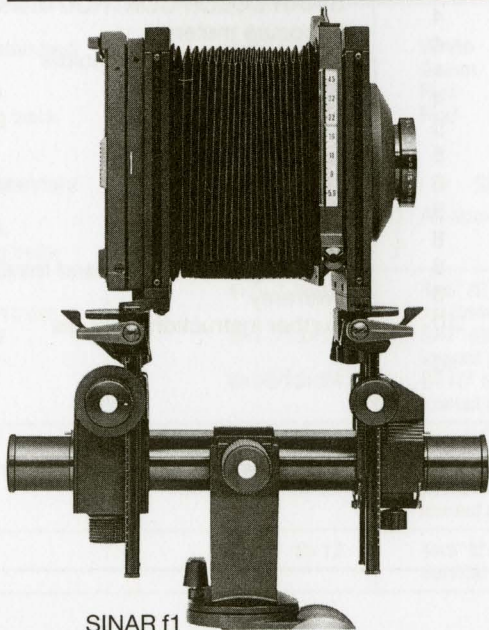

SINAR f1

The cameras

Operating controls of the SINAR p2 and c2

- 1 Coarse-focus clamping lever
- 2 Fine focusing drive with depth of field scale
- 3 Micrometer drive for vertical (rise and fall) shift
- 4 Micrometer drive for lateral (cross) shift
- 5 Micrometer drive for horizontal-axis tilts
- 6 Micrometer drive for vertical-axis swings
- 7 Image plane mark
- 8 Coarse-tilt (horizontal axis) clamping lever; movement used for vertical alignment of standards with camera inclined up or down, also for coarse tilting to reserve full micrometer tilt (5) range for sharpness distribution control.

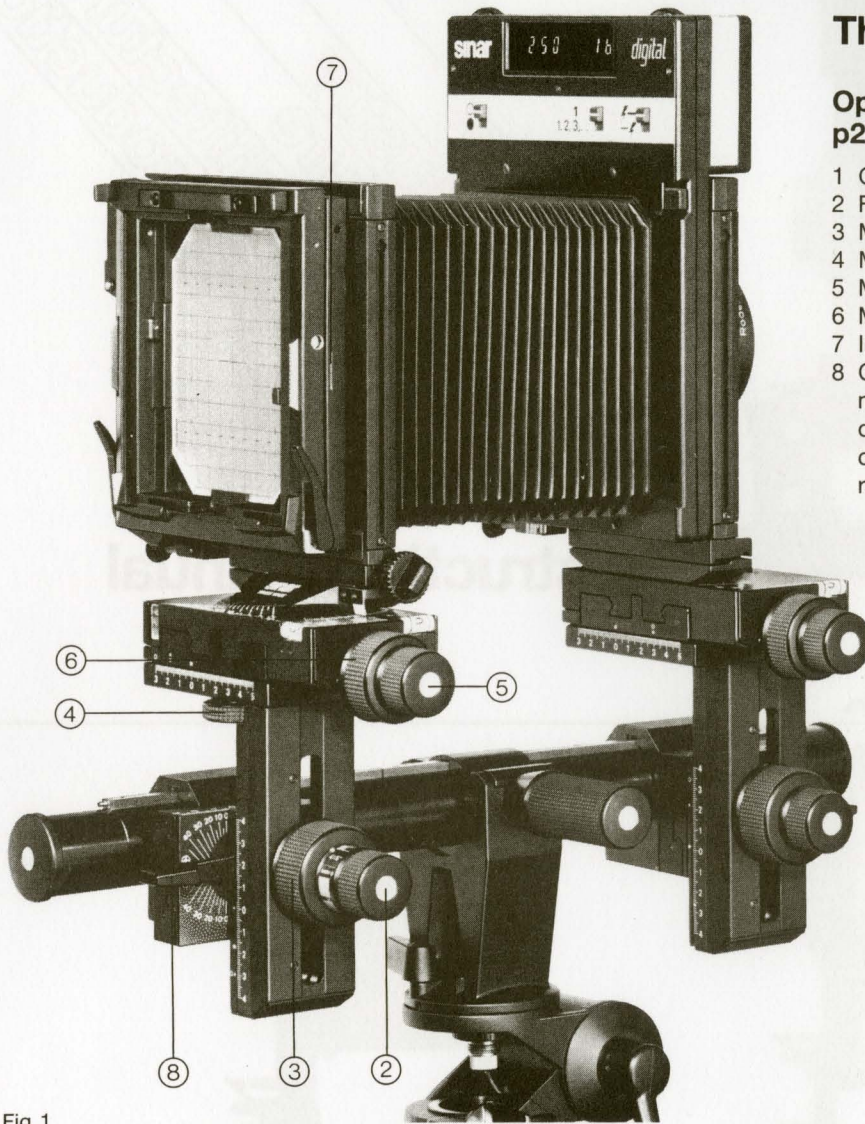

Fig. 1

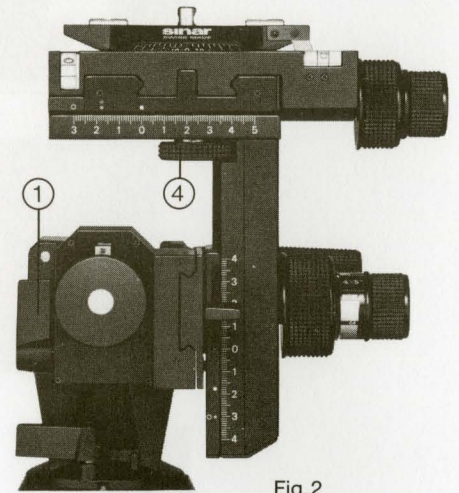

Fig. 2

Contents	The cameras	2	The plane of sharpness and depth of field	11
	- Controls	2	Further accessories	12
	- Zero settings	3	- SINAR COLOR CONTROL filters	12
	- Mounting the camera	4	- Exposure meters	12
	- The spirit levels	4	- Automatic SINAR film holder and shutter coupling	12
	- The base rail	4	- Film holders	13
	- Changing components	4	Final points	14
	- The bellows	5	- Maintenance	14
	- Camera backs	5	- Cleaning	14
	- Switching formats on the SINAR p2 and c2	6	- Adjusting the drives	14
	- Switching formats on the SINAR f2 and f1	8	- Cleaning lenses, filters and mirrors	14
	- The convertible camera	8	- Warranty	14
	- The bellows hood	9	- Further instruction manuals	14
	- Viewing aids	9		
	- Transport	10		
	The view camera movements	10		

Remark: The camera c2 is no longer part of the SINAR sales programme, but can still be combined by the individual SINAR components.

Operating controls of the SINAR f2 and f1

- 1 Coarse-focus clamping knob
- 2 Fine focussing drive with depth of field scale
- 3 Clamping wheel for vertical shift
- 4 Clamping lever for lateral shift
- 5 Clamping lever for swing (vertical axis)
- 6 Clamping lever for tilt (horizontal axis)
- 7 Angle-metering scale for tilt and swing angles
- 8 Image plane mark

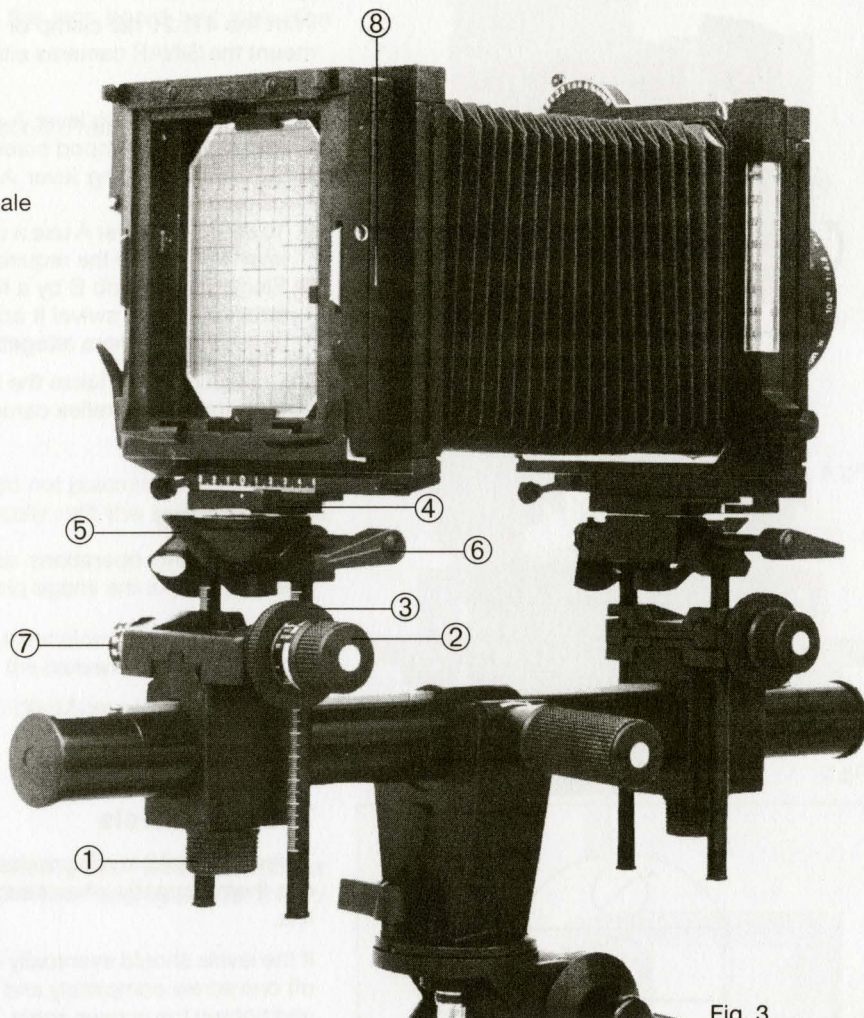

Fig. 3

Zero setting points of the cameras

CAMERA MODELS		REAR (IMAGE) STANDARD	FRONT (LENS) STANDARD	NOTES
SINAR p2				
With regular or special standard bearer	4x5 / 9x12	White } dots	White } dots	* White dot for lateral shift on special lens standard
With F/S back	5x7 /13x18	Green } dots	White } dots	
With metering back	8x10/18x24	Red } dots	Red* } dots	
	8x10/18x24	Red } rings	Red } rings	
SINAR c2				
With regular standard bearer	4x5 / 9x12	White } dots	2nd vert. eng. stop	} Lens standard at zero point for lateral shift
With F/S back	5x7 /13x18	Green } dots	2nd vertical engagement stop	
With metering back	8x10/18x24	Red } dots	3rd vert. eng. stop	
	8x10/18x24	Red } rings		
With special standard bearer	4x5 / 9x12	} As above	} As above	} Lens standard at zero point for lateral shift
With F/S back	5x7 /13x18			
With metering back	8x10/18x24			
	8x10/18x24			
SINAR f2	4x5 / 9x12	4x5" f2 standard:	4x5" f2 standard:	
With 4x5"/9x12 cm lens standard	5x7 /13x18	1st (lowest) vert. eng. stop	1st (lowest) vert. eng. stop	
	8x10/18x24	5x7" standard: lowest position	2nd vert. eng. stop	
		8x10" standard: lowest position	4th (top) vert. eng. stop	
SINAR f2	5x7 /13x18	5x7" f2 standard: lowest position	8x10" f2 special stand.: 1st (lowest) vert. eng. stop	
With special lens standard	8x10/18x24	8x10" standard: lowest position	3rd (top) vert. eng. stop	
SINAR f1	4x5 / 9x12	4x5" f2 stand.: 1st (lowest) vertical engagement stop	Multipurpose stand.: 1st (lowest) vert. eng. stop	

Mounting the camera

With the 411.21 rail clamp or 411.41 rail clamp for higher stability you can mount the SINAR cameras either on the 516.41 pan tilt head or directly on a tripod.

- Turn the clamping lever A against the arrow to release it, fit the camera and tighten the tripod screw C finger tight.
- Turn the clamping lever A in the direction of the arrow to secure the camera firmly.
- To adjust the lever A use a coin to unscrew the centre screw. Remove the lever and refit in the required position. Replace the securing screw.
- Slack off the knob B by a few turns to shift the camera along the rail for balancing or to swivel it about the rail. Slack off by a few turns more to remove the camera altogether.

The rail clamp also takes the 519.11 universal camera holder for mounting 35 mm and rollfilm reflex cameras.

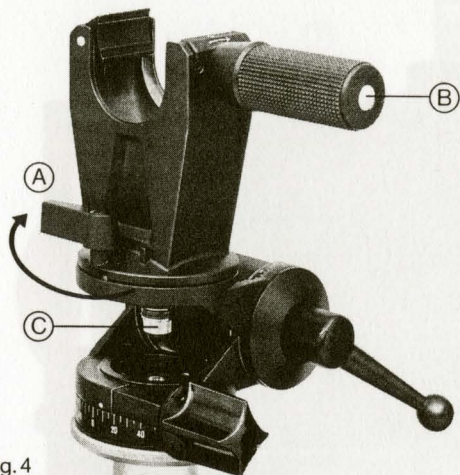

Fig. 4

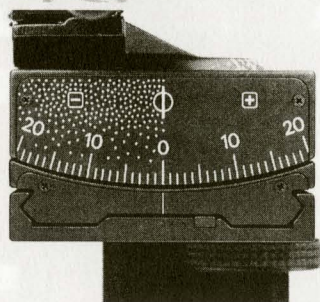

Fig. 5

Zero setting

Before starting operations set all movements to their zero engagement points. ϕ marks the image plane.

The spirit levels

To read the spirit levels precisely, view with one eye centred above them. You see them correctly when each marking ring appears truly edge-on as a thin line.

If the levels should eventually need resetting, you can do this yourself. Slack off one screw completely and the second one slightly, realign the spirit level and tighten the screws again.

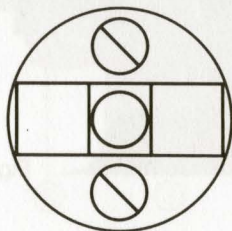

Fig. 6

The base rail

The camera outfit includes a 12"/30 cm 422.21 base rail, capped at both ends and suitable for all SINAR cameras. Rail extensions screw to either end to make up any required length. A longer 36"/90 cm 425.21 base rail is available for constant use with long extensions.

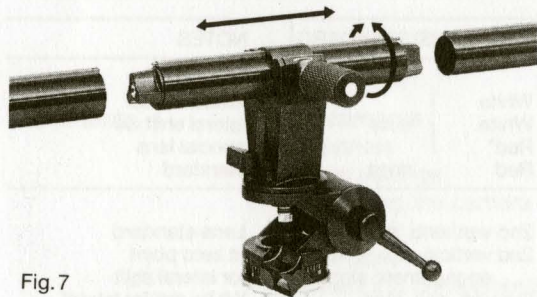

Fig. 7

Changing components

When switching metering backs, bellows, lens boards, etc on the coupling frame, always push in such items straight from above and lock. To avoid light leaks be sure to close the locking lever fully. But don't use force if the lever is hard to close – check rather that the component is correctly fitted.

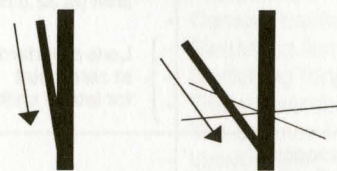

Fig. 8

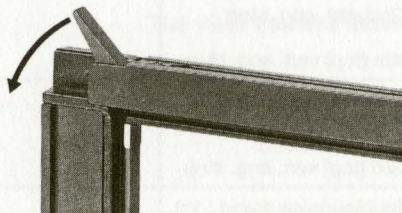

Fig. 9

When fitting lenses line up the red dot at the rear of the lens board with the red dot on the behind-lens shutter. Insert the lens board and lock. The aperture controls then couple automatically.

Lensboard holder

It is recommended to mount the 531.41 lensboard holder.

The bellows

Folding bellows

The folding bellows should never sag – so do not place anything on top of them. Also, to counteract sagging, periodically refit the bellows inverted about their axis.

The wide-angle bellows

To permit infinity focusing with short camera extensions pull any folds of the wide-angle bellows 1 fully out from between the camera standards.

Use the 455.46 wide-angle bellows 2 for 4×5"/19×12 cm pictures with 65 mm lenses and very short extensions.

Camera backs

The SINAR models p2, c2 and f2 include a metering back with probe holder (462.16 for 4×5"/9×12 cm, 462.17 for 5×7"/13×18 cm and 462.58 for 8×10"/18×24 cm).

The 461.36 back of the 4×5"/9×12 cm SINAR f1 has no meter probe holder and no lifting levers. To convert to the metering back replace the film holder frame by the 462.96 frame with probe holder. If you also want the lifting levers, replace the model 1 screen frame by the model 2, 461.56.

Fitting the back on the camera

Open the locking lever at the top left (4×5"/9×12 cm) or at the left and right (5×7"/13×18 cm and 8×10"/18×24 cm) of the rear coupling frame, insert the back at the base of the coupling frame, push home and lock (also see Figs. 8 and 9). For upright and horizontal shots you can fit the backs in alternative positions turned through 90°. (For horizontal shots position the meter probe holder at the top, for upright shots at the left.)



Fig. 10

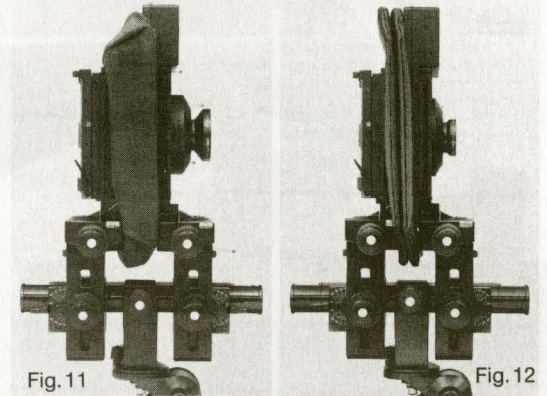

Fig. 11

Fig. 12

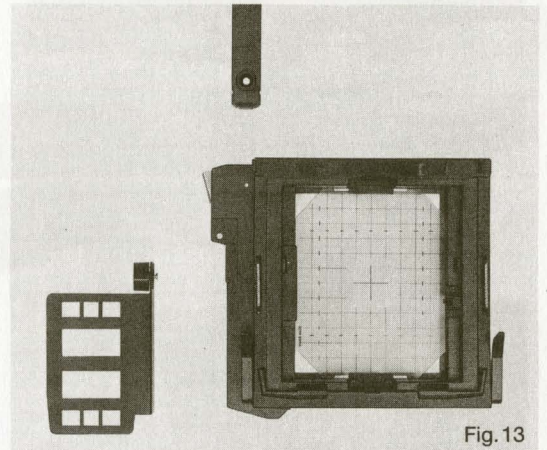

Fig. 13

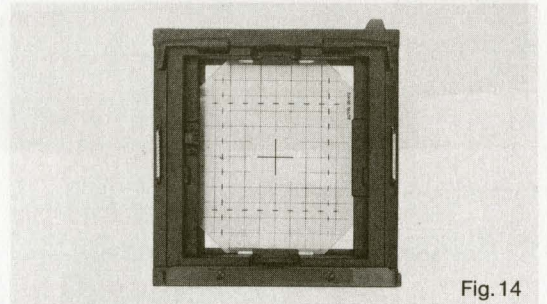

Fig. 14

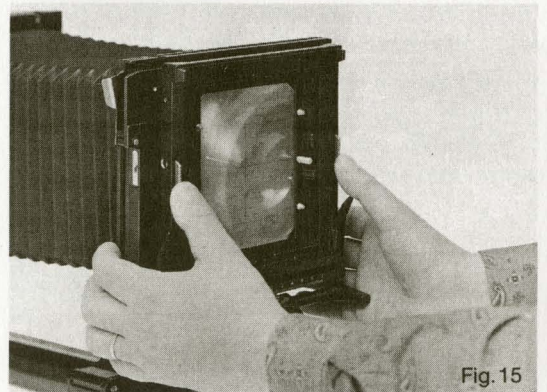

Fig. 15

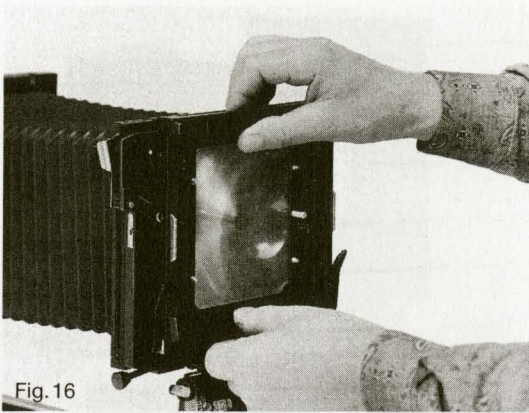

Fig. 16

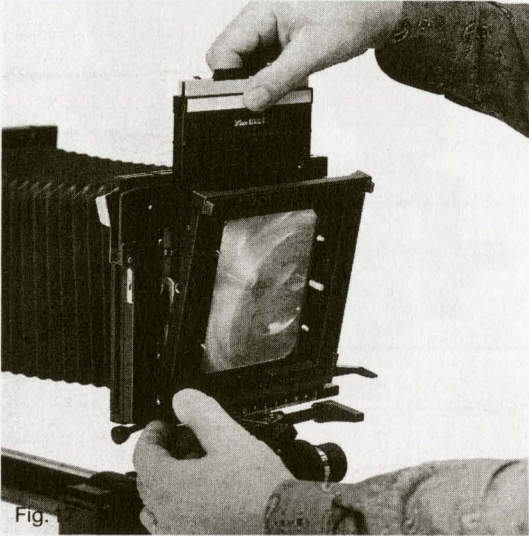

Fig.

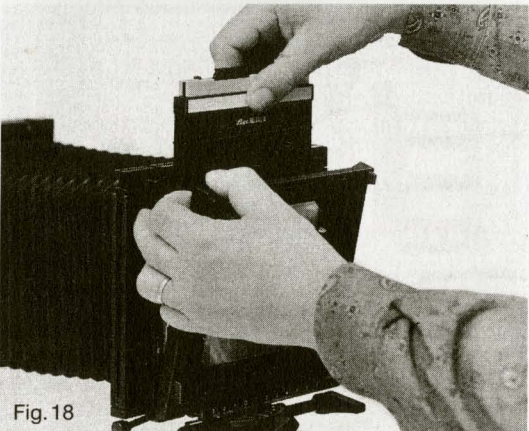

Fig. 18

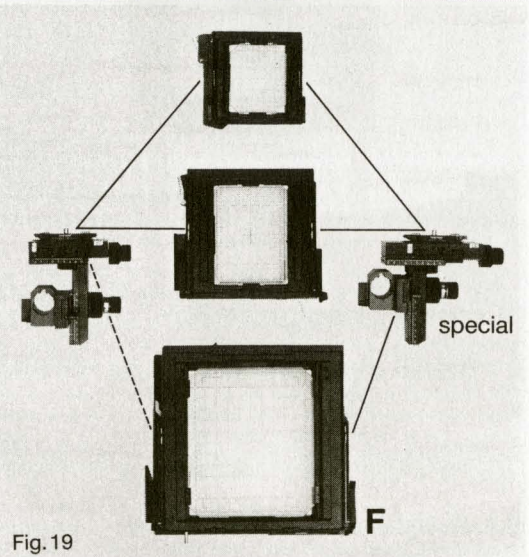

Fig. 19

Removing the screen frame (4×5"/9×12 cm back)

To separate the screen frame from the film holder frame use both thumbs to depress the serrated coupling levers at the left and right while pushing the screen frame upwards (see Fig. 15). The «Graflock» type latches at the sides of the film holder frame permit direct attachment of bulky rollfilm holders.

To reassemble, fit the screen frame shifted upwards through about 1 cm (so that the holes at the sides are level) and push down till it engages.

Inserting film holders

The metering back has lifting levers at the bottom left and right to lift the screen frame off the film holder frame. This lifting system facilitates smooth insertion of film holders. For thin film holders slightly depress one lever, push in the holder and let go. For thicker holders fully open both levers, push in the film holder and close the levers.

On a back without lifting levers lift the screen frame as shown in Fig. 18 and push in the film holder.

Switching formats on the SINAR p2 and c2

Release the bellows at the lens end. Release the rear coupling frame by turning the knob F anticlockwise. You only change the format set, consisting of the rear coupling frame, bellows and back. Set the standards to their zero positions – colour-coded with engagement stops (see table on page 3) – before switching formats.

The SINAR p2 special front standard

The zero settings on this standard are specially located for the 8×10"/18×24 cm format to make best use of the shift ranges. Use also the special rear standard bearer with the special front standard.

The SINAR p2 und c2 special rear standard bearer

This heavy-duty standard bearer, specifically designed for the 8×10"/18×24 cm format, forms the bottom section of the SINAR p2 and c2 rear standard. It makes best use of all shift, tilt and swing ranges and also has a depth of field scale.

The multipurpose standard

This serves as the lens standard on the SINAR f1. It can also be used as an object stage for close-ups and macro shots and as an intermediate standard for long camera extensions.

Set the vertical and lateral shifts to the appropriate engagement stop or coloured mark (see table on page 3) to match the location of the optical axis to the format combination used.

Raising: Slack off the clamping screw and push up the columns as shown in Fig. 21.

Lowering: See Fig. 22.

Fitting/removal:

Fully unscrew the coarse-focus clamping screw to open the hinged collar of the multipurpose standard. You can then remove the standard without dismantling the camera.

You can also reset the clamping levers of the multipurpose standard. Unscrew the retaining screw with a coin, remove the lever and refit in the required position.



Fig. 20

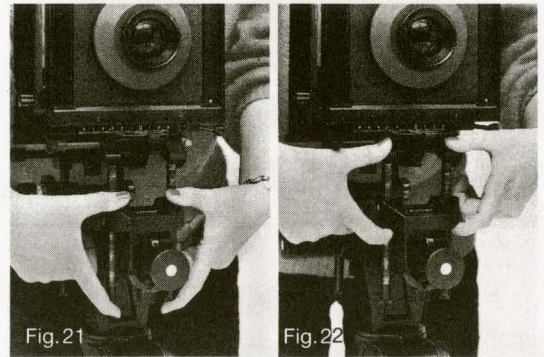

Fig. 21

Fig. 22

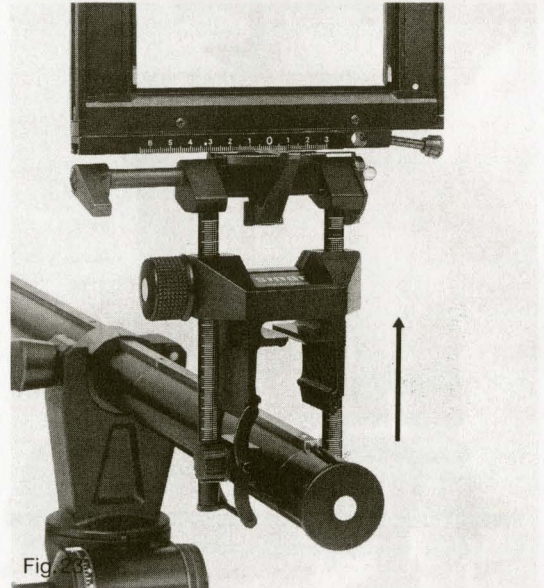

Fig. 23

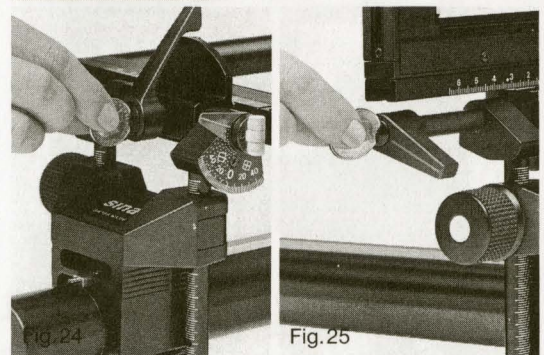

Fig. 24

Fig. 25

Switching formats on the SINAR f2 and f1

Release the bellows at the lens end and remove together with the whole rear standard (the coupling frame is here fixed to its standard bearer). Now fit the required alternative rear standard (5×7"/13×18 cm or 8×10"/18×24 cm) with its matching tapered bellows in the usual way. Format changing is thus simple and rapid. The basic design of the rear standard is the same for all three formats but the two larger sizes are reinforced and the optical axis is recentered. Operation is the same as with the 4×5"/9×12 cm rear standard. The rear standard left over after switching formats remains part of the SINAR system to serve as an auxiliary or intermediate standard.

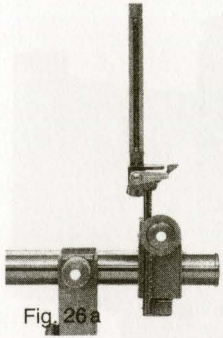

Fig. 26a

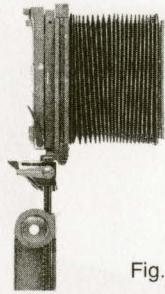

Fig. 26b



Fig. 26c



Fig. 26d



Fig. 26e

The SINAR f2 special front standard

For the 5×7"/13×18 cm and the 8×10"/18×24 cm versions of the camera we recommend the 431.62 SINAR f2 special front standard. It provides a larger shift range as its zero positions are specially aligned for these larger formats. The heavy-duty construction is also more rigid. This special lens standard is part of the 5×7"/13×18 cm and the 8×10"/18×24 cm SINAR f2 outfit.

The convertible camera

The SINAR f2 is the entry point to the versatile SINAR system with its fully compatible components. As requirements become more ambitious, changing the rear standard converts the f2 to the SINAR c2. If you then replace the lens standard by that of the p2, you have a complete SINAR p2. All elements other than the alternative camera standards remain the same. Components left over have further applications in the SINAR system. With just a few additional parts you can even use them to assemble a second camera.

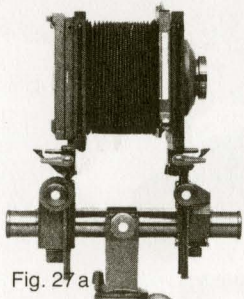

Fig. 27a

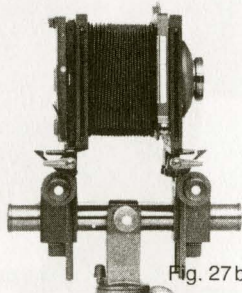

Fig. 27b

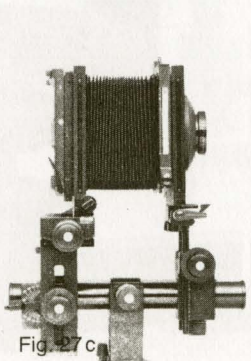

Fig. 27c

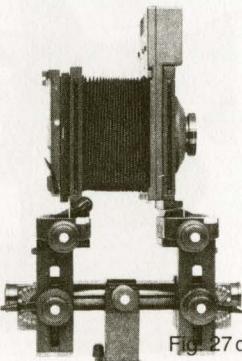

Fig. 27d

The bellows hood

The SINAR universal bellows, two bellows holders and a bellows rod or jointed rod form the simple lens hood. SINAR accessories can also make up a professional bellows hood, consisting of the bellows hood mask 1 or 2, a bellows rod, bellows holder, multipurpose standard and universal bellows. The bellows hood mask 2 has four micrometer-adjustable roller blinds with mm scales for precise masking.

To permit unobstructed shifts with short extensions do not attach the bellows to the lens.

Indirect shifts are preferable with the professional bellows hood – which is more frequently used with long extensions.

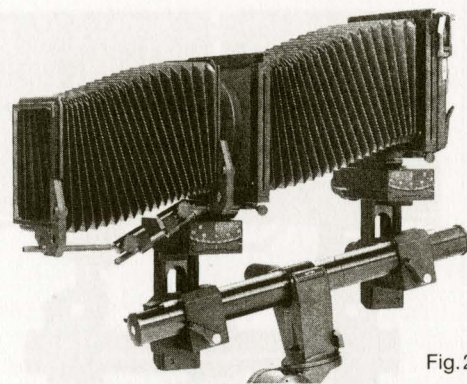

Fig. 28

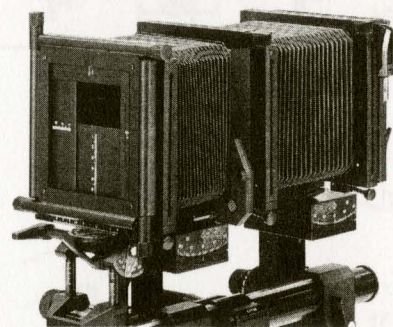

Fig. 29

For a clear view of the hood limits, to avoid image vignetting, stop down to the working aperture and sight through the cutaway corners of the ground glass screen, with the eye close to the screen.

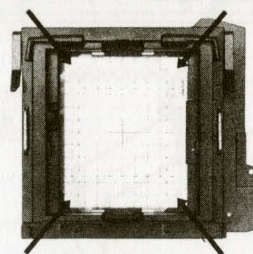

Fig. 30

Viewing aids

Fresnel screens

With a Fresnel screen you more easily take in the whole screen image – and see it brighter and with better contrast. Fresnel screens are available for all three SINAR back sizes. The ground glass screen frames have retaining springs for quick fitting and removal of the Fresnel screen.

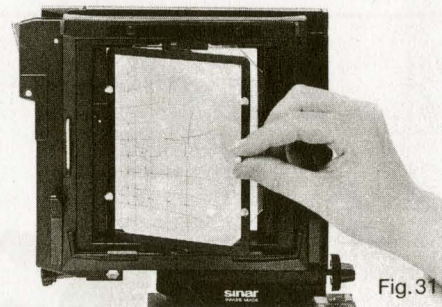

Fig. 31

The binocular magnifier and binocular reflex magnifier

A wide-angle or universal bellows attached to the screen frame keeps stray light off the ground glass screen. This viewing bellows in turn takes the binocular magnifier and its hood.

With the magnifiers swung in, the screen image appears magnified 2x. The binocular reflex magnifier also shows the image upright; it attaches directly to the 4.5x5"/9x12 cm back. To view the whole screen image with the larger sizes you also need a multipurpose standard and a tapered or wide-angle bellows behind the back. Pairs of 4.25-diopter magnifier lenses are available for both versions as an alternative to the standard 3-diopter lenses.

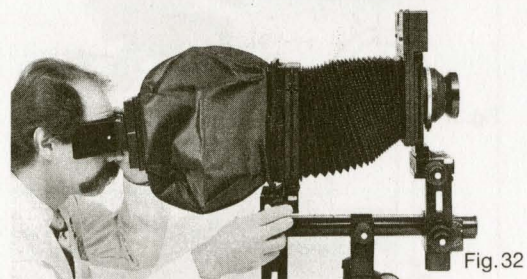

Fig. 32

Masks

To mask down the image on the ground glass screen when working with the rollfilm holders we recommend the transparent yellow masks of the 534.16 mask set or the 534.12 vario mask. The masks are available with cutouts from 4.5x6 to 8.5x10.5 cm and fit the SINAR mask and Fresnel holder. They are inserted in, and removed from, the screen frame in the same way as the Fresnel screens.

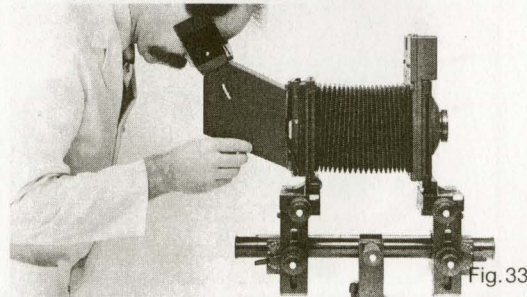

Fig. 33

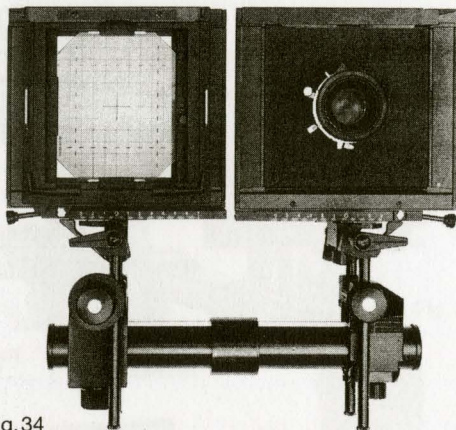

Fig. 34

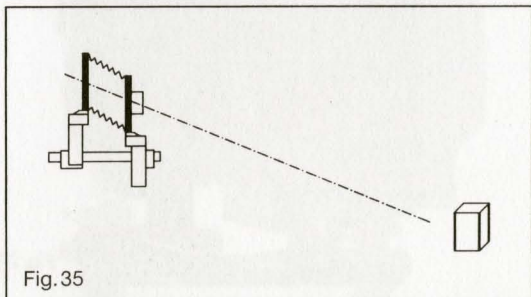

Fig. 35

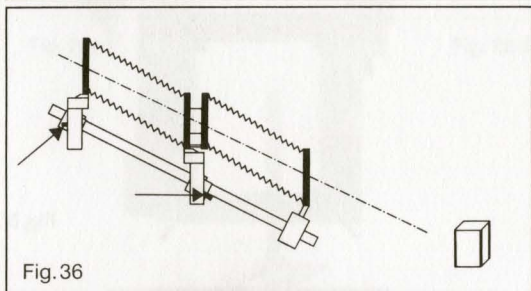

Fig. 36

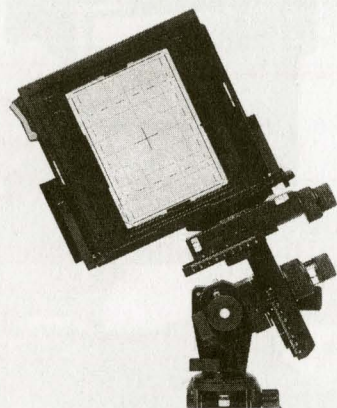

Fig. 37

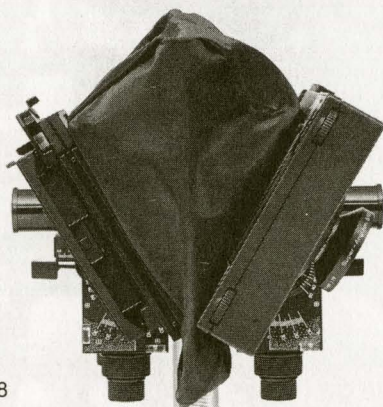

Fig. 38

Transport

The Sinar p2, c2 and f2

Before stowing the camera in the Sinar case push the two standards together clear of both the red dots on the key rail of the 422.21 base rail. In this position the camera with various accessories fits comfortably in the 475.26 case (expert or basic 4x5"/9x12 cm outfits) or in the 475.42 Sinar EXPERT case (expert outfits or basic 5x7"/13x18 cm or 8x10"/18x24 cm outfits). To protect the camera against dust and damp when set up we recommend the 571.42 dust cover (basic outfits) or the 571.52 cover (expert outfits).

The Sinar f1 and f2

You can also fold the Sinar f1 and f2 as shown in Fig. 34. Preferably leave the rail clamp on the tripod. The camera then fits in an executive-style briefcase.

The view camera movements

Direct shifts (see Fig. 35)

Suitable for short extensions (use the wide-angle bellows if necessary).

- Set up the camera level
- Adjust the shifts to centre the image

Note: Verticals appear vertical if the rear or image standard is parallel with the verticals of the object. The lens standard position affects only sharpness distribution, not perspective.

Indirect shifts (see Fig. 36)

Suitable for long extensions, with the professional bellows hood and for more extended shifts.

- Incline the camera
- Realign the standards vertically by the coarse tilt (arrows)

Usually the indirect shift method is preferable as it allows considerable inclination of the camera even with long extensions, reserves the micrometer shifts for fine adjustment and makes for a more rigid setup of the standards. Also, a bellows hood mounted on the basic rail unit, filters etc remain lined up with the optical axis.

Rotating the camera

Rotating the camera about the basic rail unit provides any intermediate position between upright and horizontal shots. Unlike a rotating back this keeps all tilt and swing axes lined up with the image axes. The bellows hood also rotates with the camera, which avoids corner vignetting. (To switch between vertical and horizontal shots turn the back round through 90°.)

Extreme tilts at short extensions

Special effects sometimes call for extreme tilts with short-focus lenses – best achieved by a vertical-axis swing of the standards. Depending on the subject position you may have to rotate the camera through 90° in the rail clamp.

The plane of sharpness and depth of field

Locating the plane of sharpness with the SINAR p2 und c2

Always establish the plane of maximum sharpness before stopping down. Select this as an imaginary subject plane with the greatest near-to-far spread of required object points.

Locating the plane of sharpness with the rear standard (controls both sharpness distribution and perspective)

- Always set the standards vertically with the coarse tilt 8.
- With the fine focusing drive 2 sharply focus a suitable first image point* on the horizontal axis H (or on the vertical axis V for a vertical-axis swing).
- With the micrometer drive 5 (or 6 for vertical-axis swings) focus on a suitable second image point – roughly opposite the first – in the shaded area of the screen.

Locating the plane of sharpness with the lens standard (controls sharpness distribution but not perspective)

- Locate the plane of maximum sharpness with the rear standard as described above, then read off the tilt or swing angle.

Direct tilting and swinging with the lens standard is not satisfactory as its optical setup always involves an overall sharpness shift.

- Then tilt the lens standard – in the same direction – to the same angle.
- Return the rear standard to its zero engagement point.
- Refocus with the fine focusing drive 2 for maximum overall sharpness. Adjust the rear standard for any final correction to the plane of sharpness.

* If there is no suitable image point on the tilt or swing axis itself, select one nearest to that axis and focus as described. Repeat the adjustment sequence until the image is sharp all over.

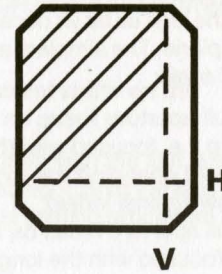

Fig. 39

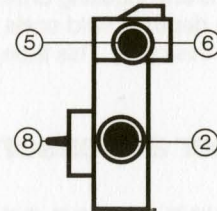

Fig. 40

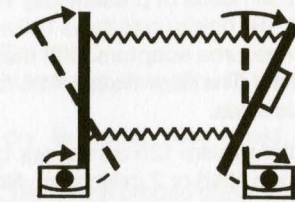

Fig. 41

Locating the plane of sharpness with the SINAR f2 and f1

Always establish the plane of maximum sharpness before stopping down. Select this as an imaginary subject plane with the greatest near-to-far spread of require object points.

- With the fine focusing drive 2 sharply focus a first image point on the horizontal axis H (or on the vertical axis V for a vertical-axis swing).
- Set the angle-metering scale 6 to zero.
- With the fine focusing drive 2 sharply focus a second image point on the opposite axis H' (or V').
- Read off the tilt angle and direction (+ or -) on the angle-metering scale 6 (for example +12°).

If the range of the angle-metering scale is not sufficient, tilt the camera setup approximately before measurement, using the intersecting planes principle.

- Set this angle (12°) and direction (here +) on either the image or the lens standard.
- Fine-focus 2 for optimum overall sharpness. Adjust the rear standard for any final correction to the plane of sharpness.

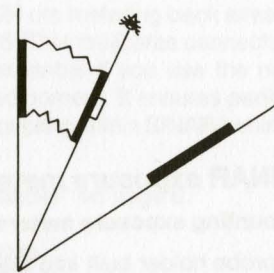

Fig. 42

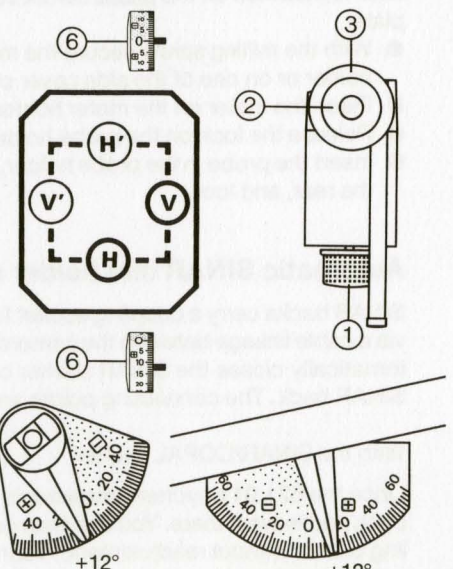

Fig. 43

Lens tilts and swings with close-ups

With close-ups (subject distance less than five times the focal length) any lens tilt causes additional problems as it also modifies the subject distance.

Here it is therefore better to control sharpness distribution with the rear standard only. If you still want to tilt the lens standard, adjust the lens tilt first by visual sighting (Fig. 42) to make the planes of the subject, lens and image meet in a common axis. Make any final adjustments again on the rear standard.

Depth of field – with all SINAR models

After locating and focusing on the plane of maximum sharpness, stop down the lens as far as necessary to extend sharpness at right angles to this plane. The simplest and quickest way is with the SINAR depth of field scale:

- At full aperture focus on the most distant subject point required sharp (i.e. focused with the shortest camera extension).
- Without changing the focus setting, zero the depth of field scale (arrow against index).
- At full aperture focus on the nearest subject point required sharp (i.e. focused with the longest camera extension).
- Read off the working aperture now shown on the scale (e.g. here f/22) and set this on the lens.
- Turn the fine focusing drive 2 back through two lens stop intervals on the depth of field scale (shortening the camera extension – to f/11 in this case). This then yields optimum focus.

Fig.44

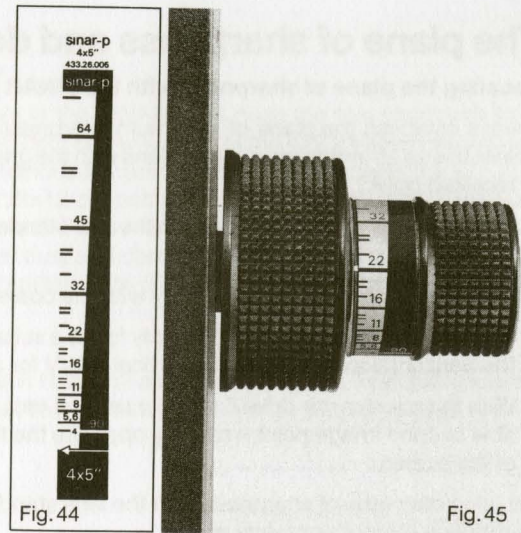

Fig.45

Further accessories

The SINAR COLOR CONTROL filter system

The SINAR COLOR CONTROL filter system 100 and 125 with over 200 different dyed-in-the-mass plastic filters plus polarising filters meets all needs of present-day view camera photography. The filter holder 100 holds up to three 100 mm filters at a time. A rapid clamping screw secures adaptors to fit the holder in the filter thread of almost any lens. The filter holder 100 further takes clip-on lens hoods of various sizes.

The filter system 125 comprises 125 mm filters held in the filter holder 1 (for one filter) or 2 (taking two filters) similar to the system 100 holders. Filter holders 1 and 2 also clip together and rotate against each other. Further, the filter holders may be mounted on any SINAR standard with the bellows holder and rod or fitted in the multipurpose standard.

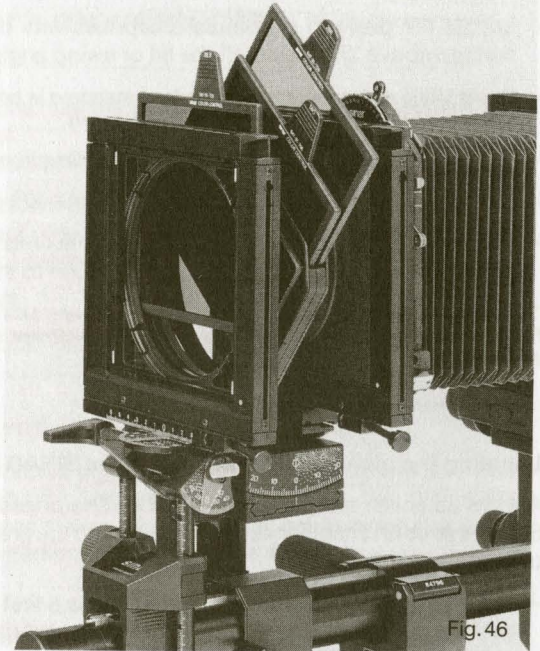

Fig.46

SINAR exposure meters and shutters

Mounting exposure meters

A probe holder built into the film holder frame of the metering back takes the metering probes of the SINAR exposure meters. The meter itself is mounted on the probe holder via the 462.96.001 meter holder plate.

- With the milling screw secure the meter holder plate on the probe holder or on one of the side cover panels of the standard.
- Place the meter on the meter holder plate and lock in place.
- Release the lock on the probe holder.
- Insert the probe in the probe holder, with the SINAR logo facing to the rear, and lock.

Automatic SINAR film holder and shutter coupling

SINAR backs carry a coupling socket for automatic shutter operation via a cable linkage between the camera back and the shutter. This automatically closes the SINAR shutter on inserting a film holder in the SINAR back. The connecting points are marked.

With the SINAR/COPAL shutter

Once the 521.91 bayonet connector is adjusted, screw it tight on the back and leave it there. You can then quickly switch automatic coupling cables without readjustment. A connector can link two automatic cables to bridge long extensions.

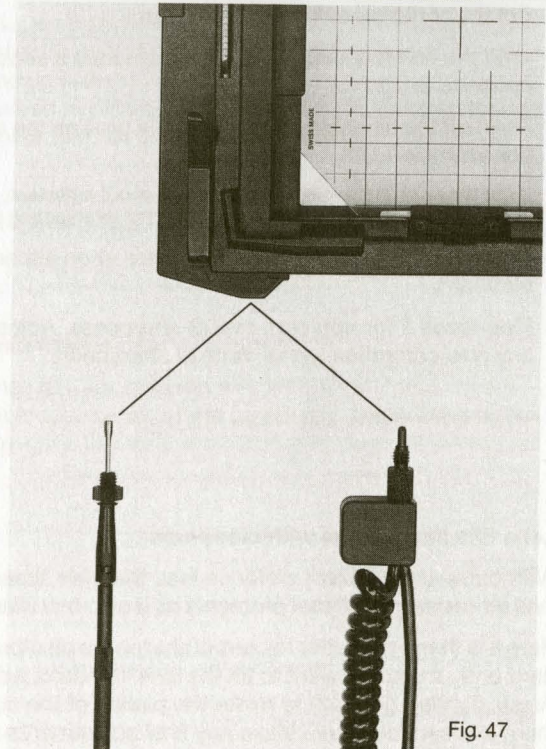

Fig.47

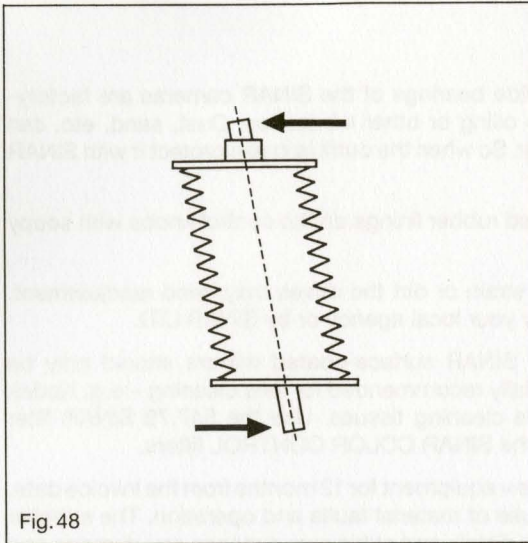

Fig.48

With the SINAR DIGITAL shutter

The release and automatic coupling cable needs no adjustment – just screw it in fully.

Automatic film holder coupling and lateral shifts on the SINAR f2 and f1

When the automatic coupling cable is fitted with the film holder upright and you want to shift the back to the right, shift the lens instead to the left. For large shifts use the indirect shifting procedure (see arrows).

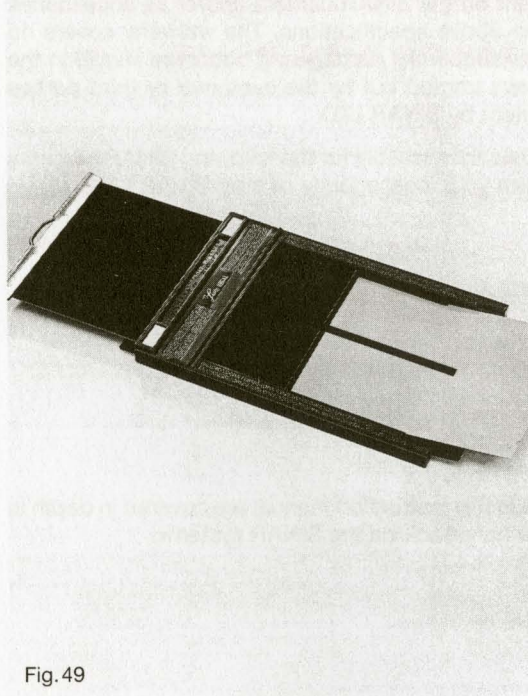

Fig.49

Film holders

Films for the view camera are loaded in separate holders. The camera can take sheet film, rollfilm and instant-picture material in sizes from 4.5x6 cm (1³/₄x2¹/₄") to 8x10"/18x24 cm.

Double sheet film holders

The film holders are easy to load. But note:

- To avoid focusing errors and light leakage always push the film in fully.
- Films that have been stored dry lie flatter. Also avoid major temperature fluctuations.
- After withdrawing the drawslide, tap on the ground glass screen to relieve any film strain.

Using LISCO Regal II sheet film holders

The film holder frame of the 8x10"/18x24 cm metering back already carries a screwed-in adapter 462.58.005. This facilitates connection of automatic coupling cables and is essential if you use the new LISCO Regal II film holders with rounded corners. It ensures perfect operation of the automatic film holder coupling with a SINAR behind-lens shutter.

Inserting the film holder: See "camera backs" on page 6.

Using SINAR sheet- and rollfilm holders

For the use of the various SINAR sheet- and rollfilm holders please consult the respective instruction manuals.

Final points

Maintenance

The plastic guides and slide bearings of the SINAR cameras are factory-lubricated and require no oiling or other lubrication. Dust, sand, etc. can however cause heavy wear. So when the outfit is in use protect it with SINAR dust covers.

Cleaning

When required, clean soiled rubber linings on the control knobs with soapy water.

Resetting the drives

Through wear, excessive strain or dirt the drives may need readjustment. This can be carried out by your local agency or by SINAR LTD.

Cleaning lenses, filters and mirrors

Lenses, glass filters and SINAR surface-coated mirrors should only be cleaned with agents specially recommended for lens cleaning – e.g. Kodak Lens Cleaner and suitable cleaning tissues. Use the 547.79 SINAR filter cleaning set for cleaning the SINAR COLOR CONTROL filters.

Warranty

The supplier guarantees new equipment for 12 months from the invoice date. The warranty covers the use of material faults and operation. The supplier undertakes to rectify immediately and at his own expense any damage and faults that become apparent on the SINAR camera and/or its accessories through failure to meet the above specifications. The warranty covers no claims beyond this, nor consequential damages. It becomes invalid in the case of alterations or repairs carried out by the customer or third parties without the written agreement by SINAR LTD.

Further instruction manuals

Separate instruction manuals are available for the following SINAR cameras and accessories. Order from your local agency or from SINAR LTD:

SINAR/COPAL shutter
SINAR DIGITAL shutter
Module 1 and 2
SINAR cases
SINAR rollfilm holders
SINAR sheet film holder
SINAR booster 1
Lenses with spring-loaded SINAR aperture control
SINAR metering backs

All the subjects mentioned in this instruction manual are covered in depth in «THE LARGE FORMAT – a handbook on the SINAR system».